

WRH ACTIVE HOT CATHODE PIRANI GAUGE

edwardsvacuum.com

The active Hot Cathode wide range gauge (WRH) offers the ability to measure from atmosphere to 10^{-10} mbar with a single gauge, with accuracy and repeatability.

The WRH gauge utilises 2 measurement methods (bayard-alpert & pirani) in a single package, giving you everything you need to measure and control your system. With analogue and RS485 output available via the D-SUB connector, 2 onboard relays and easy calibration, control and monitoring is simple. Utilising the included software, you can easily track and log your system's performance and also make adjustments to the gauges behaviour, such as setting the set points or changing the output scaling. This gauge is the perfect companion for many applications, from R&D institutes to high end mass spectrometry and through to general industry.

FEATURES AND BENEFITS

- All in one wide pressure measurement
- Dedicated software package included to allow full control/monitoring/modification
- Bakeable up to 180°C
- Analogue and RS485 output on same gauge
- LED status indicators
- 2 adjustable set points



DIMENSIONS

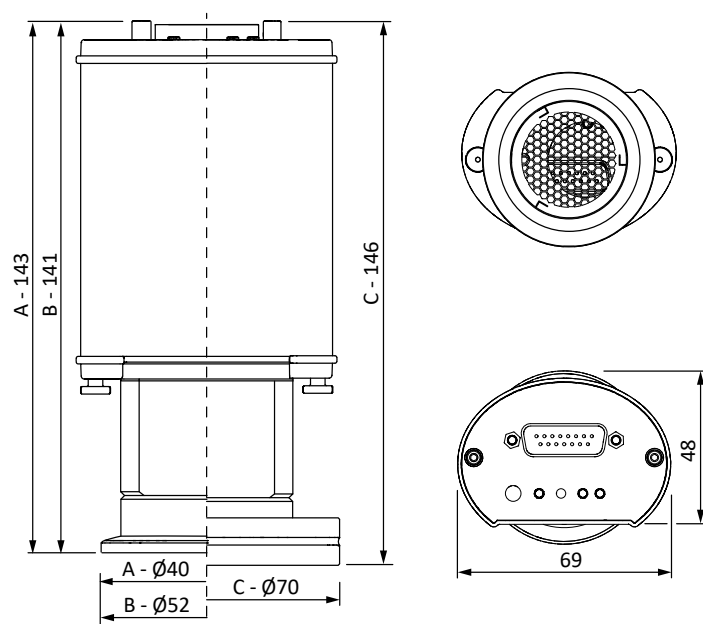

A = D14750100

B = D14750110

C = D14750120

TECHNICAL DATA

WRH	
Measuring range	1000 – 5x10 ⁻¹⁰ mbar
Accuracy	1000 to 10 mbar ± 30%, 10 to 1x10 ⁻⁸ mbar: ± 10%
Repeatability	10 to 1x10 ⁻² mbar ± 2%, 1x10 ⁻² to 1x10 ⁻⁸ mbar: ± 5%
Dimension	141 mm x 69 mm x 55 mm
Weight	0.475 kg
Max overload pressure	4 bar abs.
Materials in contact with vacuum	Stainless steel 1.4307, Tungsten, Nickel, Glass, Platinum, Iridium, Yttrium Oxide
Emission current	9 µA, 100 µA, 1.0 mA, 2.0 mA
Operating temp	+5...+60 °C
Storage temp	40...+65 °C
Bake out temp	Max. 180°C at the flange (voltage supply switched-off)
Voltage supply	20 – 30 VDC
Power consumption	Max. 8 W
Output signal	0 – 10 VDC analogue or RS485
Electrical connection	15 pin D-Sub
Protection class	IP40

ORDERING INFORMATION

Product description	Order number
WRH-NW25	D14750100
WRH-NW40	D14750110
WRH-DN40CF	D14750120
WRH-NW25 Spare sensor	D14750101
WRH-NW40 Spare sensor	D14750111
WRH-DN40CF Spare sensor	D14750121
Instruction manuals	D14750880
WRH to TIC adaptor cable	D14750100

Publication Number: 3601 0612 01
 © Edwards Limited 2022. All rights reserved. Edwards and the Edwards logo are trademarks of Edwards Limited.

Whilst we make every effort to ensure that we accurately describe our products and services, we give no guarantee as to the accuracy or completeness of any information provided in this datasheet.

Edwards Ltd., registered in England and Wales No. 6124750, registered office: Innovation Drive, Burgess Hill, West Sussex, RH15 9TW, United Kingdom.