

# nEXT TURBOMOLECULAR PUMPING STATION

edwardsvacuum.com

nEXT turbomolecular pumping stations are configurable with turbomolecular pump speeds ranging from 47 to 400  $\text{ls}^{-1}$  and a choice of oil sealed or dry backing pumps ranging from 1 to 20  $\text{m}^3\text{h}^{-1}$ . All our nEXT turbomolecular pumping stations feature an integrated TIC turbo and instrument controller offering full control of the package via a simple intuitive interface.

The nEXT turbomolecular pumping stations are supplied fully assembled and ready to run straight out of the box and include common accessories such as mist filters and mains cables as appropriate to the chosen pumps. As fully featured high end stations they include RS232 serial communications and Windows® software for monitoring and control.



## Features and benefits

### Range of turbomolecular pump options

Choice of turbomolecular pump with speeds ranging from 47 to 400  $\text{ls}^{-1}$  and inlet flanges from DN40 to DN160.

### Fully controllable

TIC turbo and instrument controller offers full control of pumps and up to 3 Active gauges as well as offering full serial remote communications.

### Vent valve option

Optional turbomolecular pump vent valve can be ordered as part of cart assembly.

### User serviceable

All nEXT turbomolecular pumps and backing pumps are fully user serviceable.

### Robust metal frame

All metal frame with locking castors for a robust but easily mobile system. Bench mounting kit included for safe bench top operation.

### Choice of backing pumps

Choice of oil sealed and dry backing pumps with capacities ranging from 1 to 20  $\text{m}^3\text{h}^{-1}$ .











### Low vibration

Backing pump mounted on anti-vibration mounts for low levels of transmitted vibration.

## 'Plug and play' turbomolecular pumping station

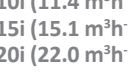
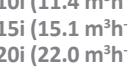
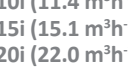
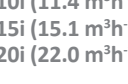
Everything about our range of nEXT turbomolecular pumping stations has been developed to provide a comprehensive vacuum solution with the latest technological advances for easy installation and operation.

A simplified ordering matrix and expanded range, to include turbopumps with speeds from 42 ls<sup>-1</sup> to 400 ls<sup>-1</sup>, enables you to select the most appropriate combination for your application, fully assembled and ready to go.

1. Choose your turbopump	2. Choose your backing pump	3. Select your voltage
 nEXT85 (84 ls <sup>-1</sup> )  nEXT240 (240 ls <sup>-1</sup> )	 E2M1.5 (1.6 m <sup>3</sup> h <sup>-1</sup> )  RV5 (5.1 m <sup>3</sup> h <sup>-1</sup> )  RV12 (12.0 m <sup>3</sup> h <sup>-1</sup> )	 XDD1 (1.2 m <sup>3</sup> h <sup>-1</sup> )  nXDS  nXDS6i (6.2 m <sup>3</sup> h <sup>-1</sup> )  nXDS10i (11.4 m <sup>3</sup> h <sup>-1</sup> )  nXDS15i (15.1 m <sup>3</sup> h <sup>-1</sup> )  nXDS20i (22.0 m <sup>3</sup> h <sup>-1</sup> )
 nEXT300 (300 ls <sup>-1</sup> )  nEXT400 (400 ls <sup>-1</sup> )		

## Ordering information

nEXT turbomolecular pumping station:

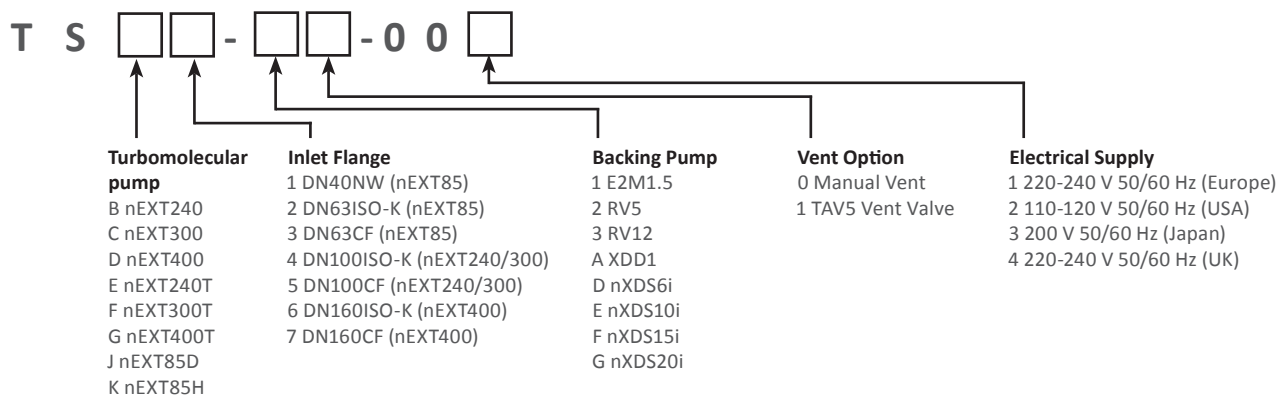

## GLOBAL CONTACTS

Publication Number: 3601 0448 01

© Edwards Limited 2018. All rights reserved Edwards and the Edwards logo are trademarks of Edwards Limited

Whilst we make every effort to ensure that we accurately describe our products and services, we give no guarantee as to the accuracy or completeness of any information provided in this datasheet.

Edwards Ltd, registered in England and Wales No. 6124750, registered office: Innovation Drive, Burgess Hill, West Sussex, RH15 9TW, UK.

### EMEA

<b>UK</b>	+44 1444 253 000 (local rate) 08459 212223
<b>Belgium</b>	+32 2 300 0730
<b>France</b>	+33 1 4121 1256
<b>Germany</b>	0800 000 1456
<b>Italy</b>	+ 39 02 48 4471
<b>Israel</b>	+ 972 8 681 0633

### ASIA PACIFIC

<b>China</b>	+86 400 111 9618
<b>India</b>	+91 20 4075 2222
<b>Japan</b>	+81 47 458 8836
<b>Korea</b>	+82 31 716 7070
<b>Singapore</b>	+65 6546 8408
<b>Taiwan</b>	+886 3758 1000

### AMERICAS

<b>USA</b>	+1 800 848 9800
<b>Brazil</b>	+55 11 3952 5000

