

# LIQUID RING VACUUM PUMPS FOR THE PROCESS INDUSTRIES

 **EDWARDS**





# EDWARDS THE PARTNER OF CHOICE

**Edwards is a world leader in the design, technology and manufacture of vacuum pumps with over 95 years' history and more than 75 years' manufacturing experience.**

We believe in delivering results that bring value to our customers by using our breadth of industry experience to identify and apply solutions to your problems. Using the most innovative and up-to-date modelling techniques, we can optimise the pumping configuration for customers to provide a system design giving the maximum performance in the most reliable and cost-effective way.



# LIQUID RING VACUUM PUMPS

As a leader in vacuum technology, Edwards has developed a portfolio of products to meet the demanding applications in process industries.

The Edwards liquid ring pump range includes both one and two stage machines enabling optimum efficiency for processes operating across the vacuum range. Pump capacities up to 40,000 m<sup>3</sup>/h are available in one stage and 7,500 m<sup>3</sup>/h in two stage models.



**LR Series** – Comprising of LR1A and LR1B models, these are one stage pumps designed for operation across the vacuum range, LR1A right down to 30 mbara whilst the LR1B pumps are optimised for applications at higher pressures above 300 mbara



**HR Series** – Includes EHR and SHR models, these are two stage construction for peak performance at low suction pressures below 150 mbara

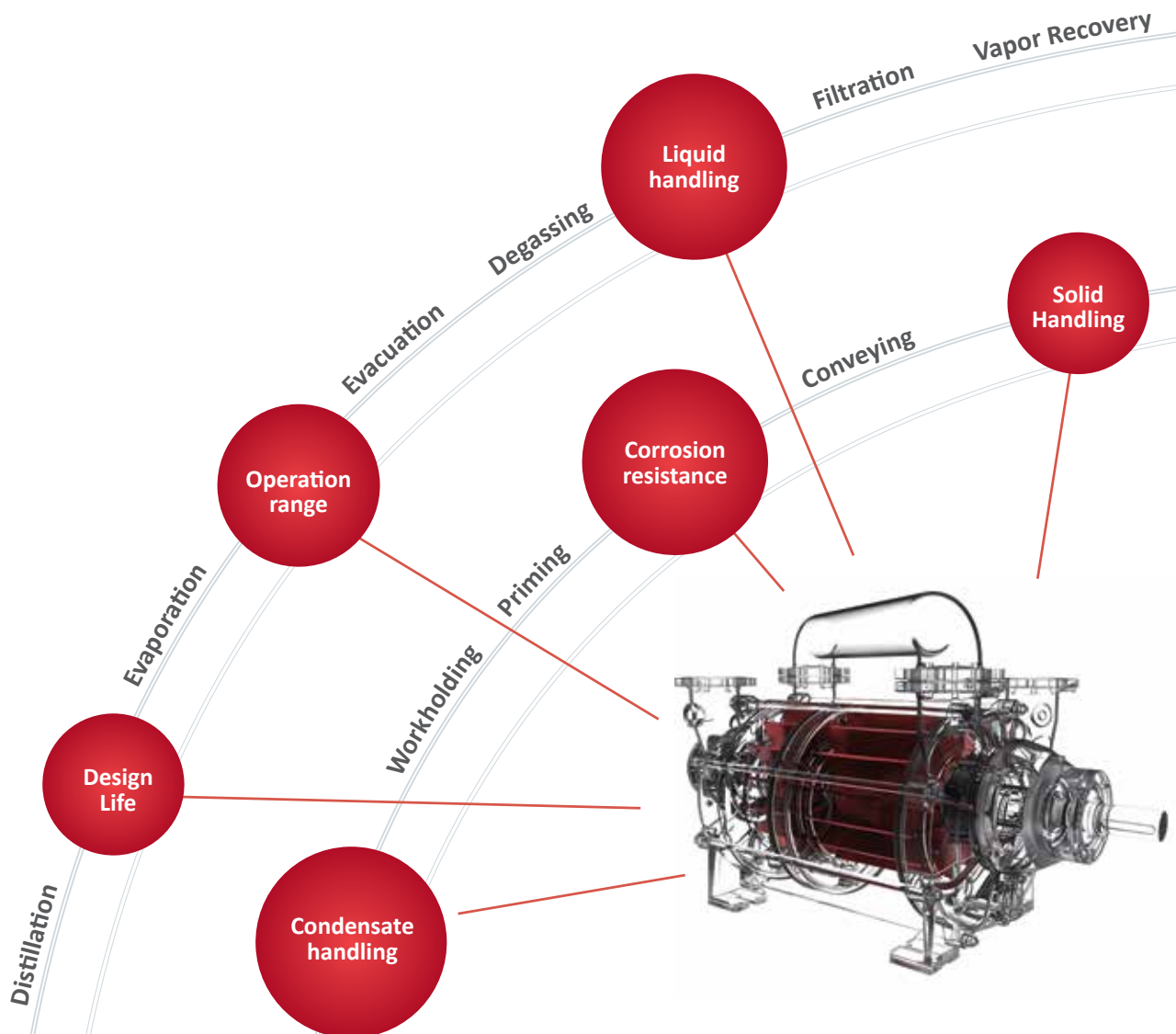



# HOW IT WORKS

The pump impeller is mounted eccentrically to the axis of the pump casing, when the impeller is rotated at the appropriate speed and a supply of liquid is introduced into the pump chamber the liquid ring is created concentrically to the pump casing. As the impeller rotates a chamber is formed by the impeller blades and the inside of the liquid ring, as this chamber is open to the suction port gas is sucked into the pump. As the impeller continues to rotate the pumping chamber reduces in size because of the eccentricity the trapped gas is compressed, once the chamber reaches the outlet port the gas is discharged at an increased pressure along with some of the seal liquid which removes the heat of compression.

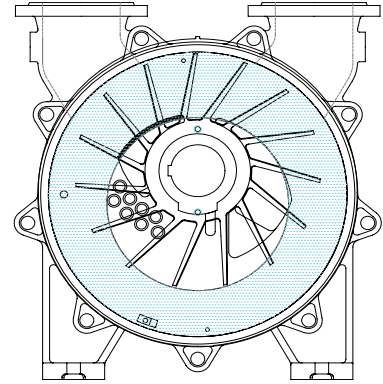

## Wet process gases

Liquid ring pumps offer significant advantages when pumping wet gases and vapours and for applications requiring special materials of construction for corrosion resistance.

The volume of incoming wet gases is reduced by cooling and condensing, this reduces the volume enabling a smaller pump to be selected.

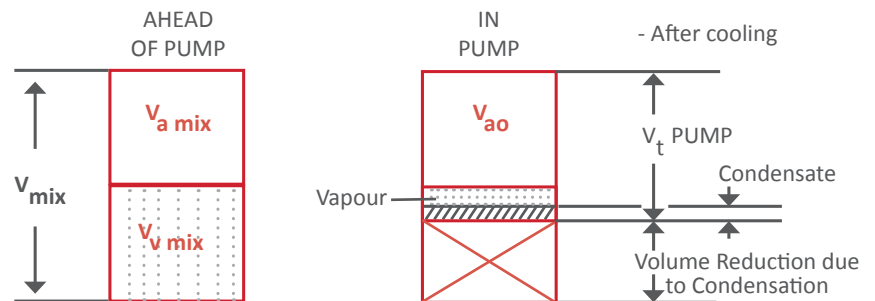

When pumping corrosive process gases or selected seal liquid is corrosive, pump materials of construction which are compatible can be selected. In addition to the standard options shown in the table below bespoke options combining different materials and special materials such as hastelloy.

## Materials of Construction options

Liquid ring pumps are well suited to operation in hazardous environments without the need for flame arrestors, pumps can be supplied suitable for operation in environments which require ATEX compliance. Please contact your local sales office for details.

Component	Standard	Stainless Fitted	Stainless Steel	Seawater ALBR	Seawater Duplex
End Casing	Cast Iron	Cast Iron	Stainless Steel	Aluminium Bronze	Duplex StSt
Impeller	SG Iron	Stainless Steel	Stainless Steel	Aluminium Bronze	Duplex StSt
Centre Body	Cast Iron	Cast Iron	Stainless Steel	Aluminium Bronze	Duplex StSt
Port Plates	Cast Iron	Cast Iron	Stainless Steel	Aluminium Bronze	Duplex StSt
Shaft	Carbon Steel	Carbon Steel	Stainless Steel	Monel	Duplex StSt
Shaft Sleeve	Stainless Steel	Stainless Steel	Stainless Steel	Monel	Duplex StSt
Shaft Seal	Carbon/SiC/Viton	Carbon/SiC/Viton	Carbon/SiC/Viton	Carbon/SiC/Viton	Carbon/SiC/Viton

## HR Series



### HR Series Pump Performance

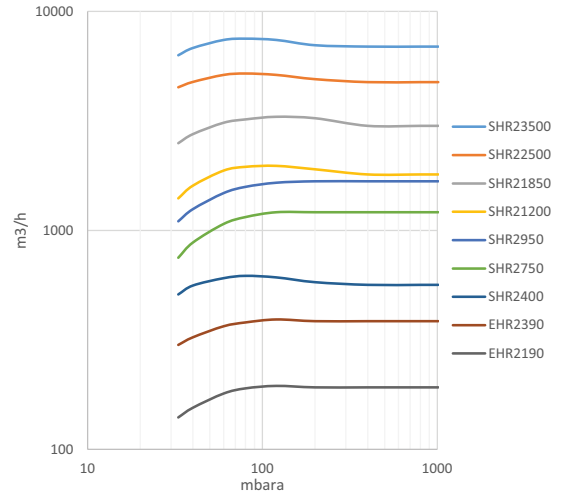

## LR1A Series



### LR1A Pump Performance

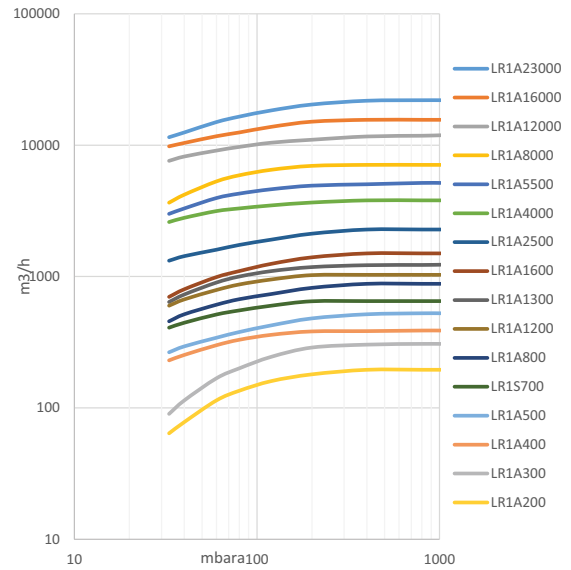

## LR1B Series



### LR1B Pump Performance

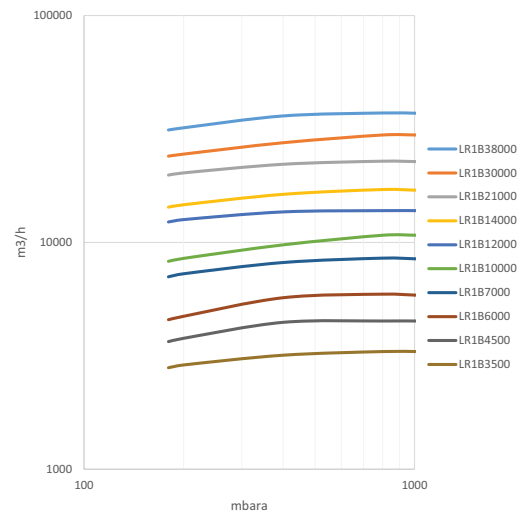

# STANDARD LRP PACKAGES

Liquid ring vacuum pump performance is dependent upon the seal liquid properties; the seal liquid must be at a temperature which is low enough to enable the pump to operate at the desired suction pressure. To minimise the amount of seal water required it is often desirable to recycle the seal water back into the liquid ring pump, to enable this either some of the water must be replaced with fresh cooled water (partial re-circulation) or it should all be cooled by a heat exchanger (total re-circulation).

Edwards liquid ring vacuum pumps are offered as standard packages in three basic configurations, for operation in once through, partial or total re-circulation mode. Additionally, pumps are available in a selection of pump materials.

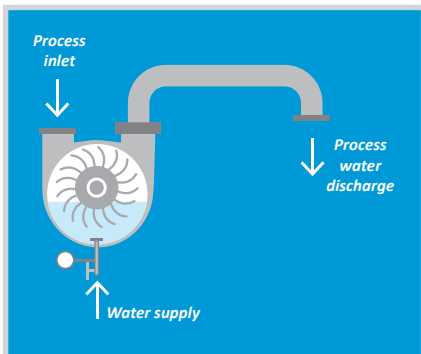

**Once Through Operation**  
Used where an ample supply of service liquid which can be discharged to drain is available.

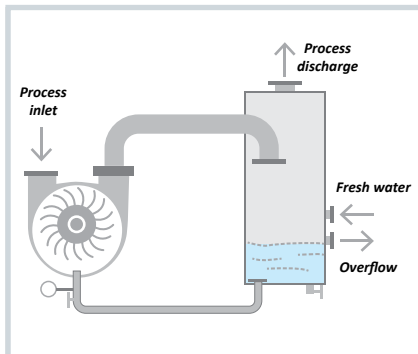

**Partial Re-circulation Operation** The discharged seal liquid and gas stream is separated in the discharge separator, fresh liquid is added to reduce the temperature of the recycled mixture and the excess liquid goes to drain. This will reduce seal liquid usage by up to 50%.

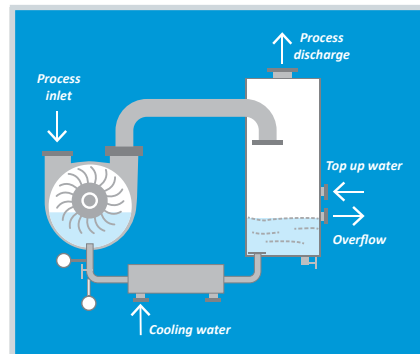

**Total Re-circulation Operation** Used when seal liquid is in short supply or contamination of drains is an issue. To enable total re-circulation the separated liquid must be cooled before it is re-used. This is done by including a plate type heat exchanger in the return line.

## Maximum Seal Water Temperature

When using water as the seal liquid the maximum temperature of seal water required to enable operation at a specific pressure is shown in the table below.

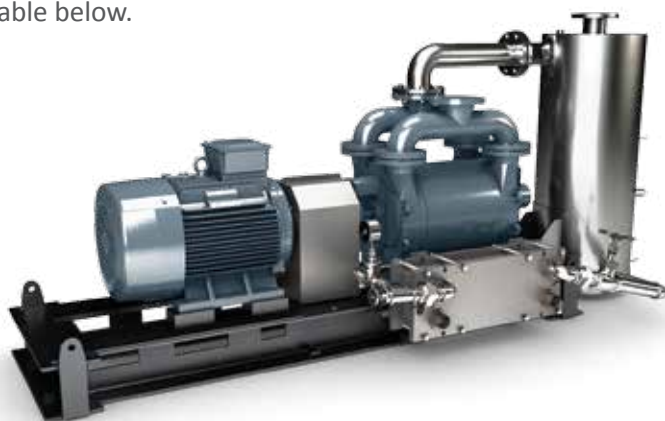

Inlet Water Temperature °C	Minimum Suction Pressure mbara
15	33
20	40
25	50
32	60
38	80
45	100

# ENGINEERED TO ORDER SYSTEMS

Complex packages are designed to meet the customer or process licence specifications., generally requiring project specific quality assurance program and extensive documentation packages.

Edwards have many years experience in the design, engineering, assembly and testing of bespoke liquid ring pump and hybrid vacuum systems for the process markets, with equipment supplied for various process applications, including production of; aromatics, LAB, styrene, BPA, PTA, biofuels, fertilisers, adhesives and many others, providing customised solutions to meet customer requirements.



## **Petrochemical**

Vacuum Distillation,  
Vapour Recovery



## **Power Generation**

Condenser air extraction,  
Deaeration, Waterbox  
priming, Ash handling,  
Filtration

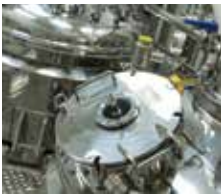

## **Chemical**

Distillation, Evaporation,  
Filtration, Polymerisation,  
Deoderisation,  
Polymerisation



## **Offshore**

Seawater deaeration,  
MEG recovery, Drilling  
mud recovery



## **Pharmaceutical & Fine Chemical**

Filter drying, Degassing,  
Crystallisation,  
Conveying



## **Food Processing**

Crystallisation,  
Evaporation,  
Filtration, Freeze  
Drying

For more information on specific applications please contact you local Edwards sales office.







## GLOBAL CONTACTS

Publication Number: 3602 602 6 01  
 © Edwards Limited 2017. All rights reserved  
 Edwards and the Edwards logo are trademarks of  
 Edwards Limited

Whilst we make every effort to ensure that we  
 accurately describe our products and services,  
 we give no guarantee as to the accuracy or  
 completeness of any information provided in  
 this brochure.

Edwards Ltd, registered in England and Wales  
 No. 6124750, registered office: Innovation Drive,  
 Burgess Hill, West Sussex, RH15 9TW, UK.

### EMEA

<b>UK</b>	+44 1444 253 000 (local rate) 08459 212223
<b>Belgium</b>	+32 2 300 0730
<b>France</b>	+33 1 4121 1256
<b>Germany</b>	0800 000 1456
<b>Italy</b>	+ 39 02 48 4471
<b>Israel</b>	+ 972 8 681 0633

### ASIA PACIFIC

<b>China</b>	+86 400 111 9618
<b>India</b>	+91 20 4075 2222
<b>Japan</b>	+81 47 458 8836
<b>Korea</b>	+82 31 716 7070
<b>Singapore</b>	+65 6546 8408
<b>Taiwan</b>	+886 3758 1000

### AMERICAS

<b>USA</b>	+1 800 848 9800
<b>Brazil</b>	+55 11 3952 5000